



FEATURES

Six Direct Voltage Measurement Inputs (Including Two Processor Core Voltages) with On-Chip Attenuators

On-Chip Temperature Sensor

Five Digital Inputs for VID Bits

Fully Supports Intel's LANDesk Client Manager (LDCM)

Register-Compatible with LM7x Products

Two Fan Speed Monitoring Inputs

I²C® Compatible System Management Bus (SMBus)

Chassis Intrusion Detect

Interrupt Output

Programmable RESET I/O Pin

Shutdown Mode to Minimize Power Consumption

Limit Comparison of all Monitored Values

APPLICATIONS

Network Servers and Personal Computers

Microprocessor-Based Office Equipment

Test Equipment and Measuring Instruments

PRODUCT DESCRIPTION

The ADM9240 is a complete system hardware monitor for microprocessor-based systems, providing measurement and limit comparison of up to four power supplies and two processor core voltages, plus temperature, two fan speeds and chassis intrusion. Measured values can be read out via an I²C-compatible serial System Management Bus, and values for limit comparisons can be programmed in over the same serial bus. The high speed successive approximation ADC allows frequent sampling of all analog channels to ensure a fast interrupt response to any out-of-limit measurement.

The ADM9240's 2.85 V to 5.75 V supply voltage range, low supply current and I²C compatible interface, make it ideal for a wide range of applications. These include hardware monitoring and protection applications in personal computers, electronic test equipment and office electronics.

FUNCTIONAL BLOCK DIAGRAM

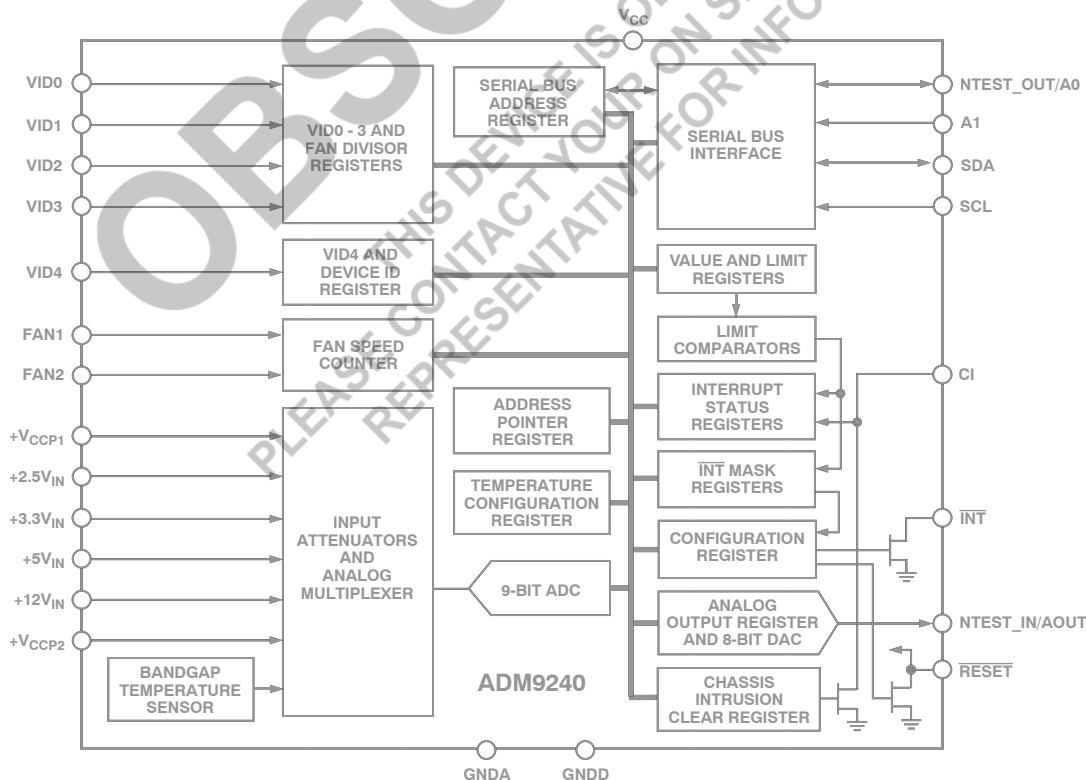

I²C is a registered trademark of Philips Corporation.

ADM9240—SPECIFICATIONS^{1, 2}

($T_A = T_{MIN}$ to T_{MAX} , $V_{CC} = V_{MIN}$ to V_{MAX} , unless otherwise noted)

Parameter	Min	Typ	Max	Units	Test Conditions/Comments
POWER SUPPLY					
Supply Voltage, V_{CC}	2.85	5	5.75	V	Interface Inactive, ADC Active ADC Inactive, DAC Active Shutdown Mode
Supply Current, I_{CC}		1.4	2.0	mA	
		1.0		mA	
		25	100	μ A	
TEMPERATURE-TO-DIGITAL CONVERTER					
Accuracy			± 3	$^{\circ}$ C	-40° C $\leq T_A \leq +125^{\circ}$ C $T_A = +25^{\circ}$ C
			± 2	$^{\circ}$ C	
Resolution		± 0.5		$^{\circ}$ C	
ANALOG-TO-DIGITAL CONVERTER (INCLUDING MUX AND ATTENUATORS)					
Total Unadjusted Error, TUE			± 2	%	Note 3
Differential Nonlinearity, DNL			± 1	LSB	
Power Supply Sensitivity		± 1		%/V	$+25^{\circ}$ C $\leq T_A \leq +125^{\circ}$ C (Note 4) -40° C $\leq T_A \leq +125^{\circ}$ C (Note 4)
Total Monitoring Cycle Time		311	331	μ s	
		311	353	μ s	
Input Resistance	100	140	200	k Ω	
ANALOG OUTPUT					
Output Voltage Range	0		1.25	V	$I_L = 2$ mA
Total Unadjusted Error, TUE			± 3	%	
Full-Scale Error		± 1	± 3	%	No Load
Zero Error		2		LSB	
Differential Nonlinearity, DNL			± 1	LSB	Monotonic by Design
Integral Nonlinearity		± 1		LSB	
Output Source Current		2		mA	
Output Sink Current		1		mA	
FAN RPM-TO-DIGITAL CONVERTER					
Accuracy			± 6	%	$+25^{\circ}$ C $\leq T_A \leq +125^{\circ}$ C
			± 12	%	-40° C $\leq T_A \leq +125^{\circ}$ C
Full-Scale Count			255		
FAN1 and FAN2 Nominal Input RPM		8800		rpm	Divisor = 1, Fan Count = 153 (Note 5)
		4400		rpm	Divisor = 2, Fan Count = 153 (Note 5)
		2200		rpm	Divisor = 3, Fan Count = 153 (Note 5)
		1100		rpm	Divisor = 4, Fan Count = 153 (Note 5)
Internal Clock Frequency	21.1	22.5	23.9	kHz	$+25^{\circ}$ C $\leq T_A \leq +125^{\circ}$ C
	19.8	22.5	25.2	kHz	-40° C $\leq T_A \leq +125^{\circ}$ C
DIGITAL OUTPUT NTEST_OUT					
Output High Voltage, V_{OH}	2.4			V	$I_{OUT} = 5.0$ mA, $V_{CC} = 4.25$ V– 5.75 V
	2.4			V	$I_{OUT} = 3.0$ mA, $V_{CC} = 2.85$ V– 3.45 V
Output Low Voltage, V_{OL}			0.4	V	$I_{OUT} = -5.0$ mA, $V_{CC} = 4.25$ V– 5.75 V
			0.4	V	$I_{OUT} = -3.0$ mA, $V_{CC} = 2.85$ V– 3.45 V
OPEN-DRAIN DIGITAL OUTPUTS (INT, RESET, CI)					
Output Low Voltage, V_{OL}			0.4	V	$I_{OUT} = -5.0$ mA, $V_{CC} = 5.75$ V
			0.4	V	$I_{OUT} = -3.0$ mA, $V_{CC} = 3.45$ V
High Level Output Current, I_{OH}		0.1	100	μ A	$V_{OUT} = V_{CC}$
RESET and CI Pulsewidth	20	45		ms	

Parameter	Min	Typ	Max	Units	Test Conditions/Comments
OPEN-DRAIN SERIAL DATA BUS OUTPUT (SDA) Output Low Voltage, V_{OL}			0.4	V	$I_{OUT} = -3.0$ mA, $V_{CC} = 4.25$ V–5.75 V
			0.4	V	$I_{OUT} = -3.0$ mA $V_{CC} = 2.85$ V–3.45 V
High Level Output Current, I_{OH}		0.1	100	μ A	$V_{OUT} = V_{CC}$
SERIAL BUS DIGITAL INPUTS (SCL, SDA) Input High Voltage, V_{IH} Input Low Voltage, V_{IL} Hysteresis	$0.7 \times V_{CC}$		$0.3 \times V_{CC}$	V V mV	
DIGITAL INPUT LOGIC LEVELS (A0, A1, CI, <u>RESET</u> , VID0 – VID4, FAN1, FAN2) Input High Voltage, V_{IH} Input Low Voltage, V_{IL} Input High Voltage, V_{IH} Input Low Voltage, V_{IL} NTEST_IN Input High Voltage, V_{IH} Input High Voltage, V_{IH}	2.4 2.0 2.4 2.0		0.8 0.4	V V V V V V	$V_{CC} = 4.25$ V–5.75 V $V_{CC} = 4.25$ V–5.75 V $V_{CC} = 2.85$ V–3.45 V $V_{CC} = 2.85$ V–3.45 V $V_{CC} = 4.25$ V–5.75 V $V_{CC} = 2.85$ V–3.45 V
DIGITAL INPUT CURRENT Input High Current, I_{IH} Input High Current, A0, A1, I_{IH} Input Low Current, I_{IL} Input Capacitance, C_{IN}	-1 -200	75	1	μ A μ A μ A pF	$V_{IN} = V_{CC}$ $V_{IN} = V_{CC}$ (Note 6) $V_{IN} = 0$
SERIAL BUS TIMING ⁷ Clock Frequency, f_{SCLK} Glitch Immunity, t_{SW} Bus Free Time, t_{BUF} Start Setup Time, $t_{SU:STA}$ Start Hold Time, $t_{HD:STA}$ SCL Low Time, t_{LOW} SCL High Time, t_{HIGH} SCL, SDA Rise Time, t_R SCL, SDA Fall Time, t_F Data Setup Time, $t_{SU:DAT}$ Data Hold Time, $t_{HD:DAT}$			400 50 1.3 600 600 1.3 0.6 300 300 100 900	kHz ns μ s ns ns μ s μ s ns μ s ns ns	See Figure 1 See Figure 1 See Figure 1 See Figure 1 See Figure 1 See Figure 1 See Figure 1 See Figure 1 See Figure 1 See Figure 1 See Figure 1 See Figure 1

NOTES

¹All voltages are measured with respect to GND, unless otherwise noted.

²Typicals are at $T_A = +25^\circ\text{C}$ and represent most likely parametric norm. Shutdown current typ is measured with $V_{CC} = 3.3$ V.

³TUE (Total Unadjusted Error) includes Offset, Gain and Linearity errors of the ADC, multiplexer and on-chip input attenuators, including an external series input protection resistor value between zero and 1 k Ω .

⁴Total monitoring cycle time is the time taken to measure all six analog inputs plus the temperature sensor.

⁵The total fan count is based on 2 pulses per revolution of the fan tachometer output.

⁶A0 and A1 have internal 75 k Ω pull-down.

⁷Timing specifications are tested at logic levels of $V_{IL} = 0.3 \times V_{CC}$ for a falling edge and $V_{IH} = 0.7 \times V_{CC}$ for a rising edge.

Specifications subject to change without notice.

ADM9240

ABSOLUTE MAXIMUM RATINGS*

Positive Supply Voltage (V_{CC})	6.5 V
Voltage on Any Input or Output Pin (Except Analog Inputs)	-0.3 V to ($V_{CC} + 0.3$ V)
16 V V_{IN}	+16 V
All Other Analog Inputs	+7.5 V
Ground Difference (GNDD-GNDA)	± 300 mV
Input Current At Any Pin	± 5 mA
Package Input Current	± 20 mA
Maximum Junction Temperature (T_J max)	150°C
Storage Temperature Range	-65°C to +150°C
Lead Temperature, Soldering	
Vapor Phase 60 (sec)	+215°C
Infrared 15 (sec)	+200°C
ESD Rating All Pins Except Pin 15	2000 V
ESD Rating Pin 15	500 V

*Stresses above those listed under Absolute Maximum Ratings may cause permanent damage to the device. This is a stress rating only; functional operation of the device at these or any other conditions above those indicated in the operational section of this specification is not implied. Exposure to absolute maximum rating conditions for extended periods may affect device reliability.

THERMAL CHARACTERISTICS

24-Lead Small Outline Package:

$$\theta_{JA} = 50^\circ\text{C/Watt}, \theta_{JC} = 10^\circ\text{C/Watt}$$

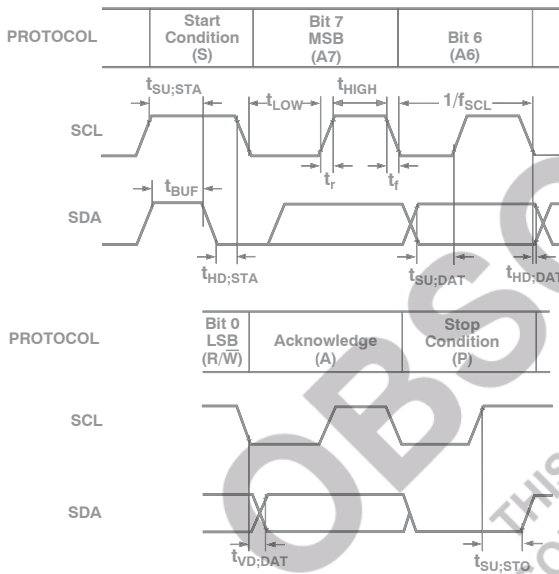

Figure 1. Diagram for Serial Bus Timing

PIN CONFIGURATION

Pin	Function	Pin	Function
1	NTEST_OUT/A0	24	VID0
2	A1	23	VID1
3	SDA	22	VID2
4	SCL	21	VID3
5	FAN1	20	VID4
6	FAN2	19	+V _{CCP1}
7	CI	18	+2.5V _{IN}
8	GNDD	17	+3.3V _{IN}
9	V _{CC}	16	+5V _{IN}
10	INT	15	+12V _{IN}
11	NTEST_IN/AOUT	14	+V _{CCP2}
12	RESET	13	GNDA

ADM9240
TOP VIEW
(Not to Scale)

PIN FUNCTION DESCRIPTIONS

Pin Number	Mnemonic	Description
1	NTEST_OUT/A0	Digital I/O. Dual Function Pin. The lowest order programmable bit of the Serial Bus Address. This pin functions as an output when doing a NAND Tree test.
2	A1	Digital Input. The highest order programmable bit of the Serial Bus Address.
3	SDA	Digital I/O. Serial Bus Bidirectional Data. Open-drain output.
4	SCL	Digital Input. Serial Bus Clock.
5	FAN1	Digital Input. 0 to V_{CC} amplitude fan tachometer input.
6	FAN2	Digital Input. 0 to V_{CC} amplitude fan tachometer input.
7	CI	Digital I/O. An active high input from an external circuit that latches a Chassis Intrusion event. This line can go high without any clamping action regardless of the powered state of the ADM9240. The ADM9240 provides an internal open drain on this line, controlled by Bit 6 of Register 40h or Bit 7 of Register 46h, to provide a minimum 20 ms pulse on this line, to reset the external Chassis Intrusion Latch.
8	GNDD	Digital Ground. Internally connected to all of the digital circuitry.
9	V_{CC}	Power (+2.85 V to +5.75 V). Typically powered from +3.3 V or +5 V power rail. Bypass with the parallel combination of 10 μ F (electrolytic or tantalum) and 0.1 μ F (ceramic) bypass capacitors.
10	\overline{INT}	Digital Output. Interrupt Request (open drain). The output is enabled when Bit 1 of the Configuration Register is set to 1. The default state is disabled.
11	NTEST_IN/AOUT	Digital Input/Analog Output. An active-high input that enables NAND Tree mode board-level connectivity testing. Refer to section on NAND Tree testing. Also functions as a programmable analog output when NAND Tree is not selected
12	\overline{RESET}	Digital I/O. Master Reset, 5 mA driver (open drain), active low output with a 20 ms minimum pulsewidth. Available when enabled via Bit 7 in Register 44h, and set using Bit 4 in Register 40h. Also acts as reset input when pulled low (e.g., power-on reset).
13	GNDA	Analog Ground. Internally connected to all analog circuitry. The ground reference for all analog inputs.
14	+ V_{CCP2}	Analog Input. Monitors processor core voltage + V_{CCP2} (0 V–3.6 V). Can also be used to monitor the –12 V supply by adding two external resistors.
15	+12 V_{IN}	Analog Input. Monitors +12 V supply.
16	+5 V_{IN}	Analog Input. Monitors +5 V supply.
17	+3.3 V_{IN}	Analog Input. Monitors +3.3 V supply.
18	+2.5 V_{IN}	Analog Input. Monitors +2.5 V supply.
19	+ V_{CCP1}	Analog Input. Monitors processor core voltage + V_{CCP1} (0 V–3.6 V).
20	VID4	Digital Input. Core Voltage ID readouts from the processor. This value is read into the VID4 Status Register.
21	VID3	Digital Input. Core Voltage ID readouts from the processor. This value is read into the VID0–VID3 Status Register.
22	VID2	Digital Input. Core Voltage ID readouts from the processor. This value is read into the VID0–VID3 Status Register.
23	VID1	Digital Input. Core Voltage ID readouts from the processor. This value is read into the VID0–VID3 Status Register.
24	VID0	Digital Input. Core Voltage ID readouts from the processor. This value is read into the VID0–VID3 Status Register.

ADM9240

GENERAL DESCRIPTION

The ADM9240 is a complete system hardware monitor for microprocessor-based systems. The device communicates with the system via a serial System Management Bus. The serial bus controller has two hardwired address lines for device selection (Pin 1 and Pin 2), a serial data line for reading and writing addresses and data (Pin 3), and an input line for the serial clock (Pin 4). All control and programming functions of the ADM9240 are performed over the serial bus.

An on-chip analog-to-digital converter with six multiplexed analog inputs measures power supply voltages (+12 V, +5 V, +3.3 V, +2.5 V—Pins 15 to 18) and processor core voltages (+V_{CCP1} and +V_{CCP2}—Pins 19 and 14). The ADC also accepts input from an on-chip bandgap temperature sensor that monitors system ambient temperature.

Two count inputs (Pins 5 and 6) are provided for monitoring the speed of fans with tachometer outputs. To accommodate fans with different speeds and different tacho outputs, a divisor of 1, 2, 4 or 8 can be programmed into the counter.

Five digital inputs (VID4 to VID0—Pins 20 to 24) read the processor Voltage ID code, while a chassis intrusion input (Pin 7) is provided to detect unauthorized tampering with the equipment.

When the ADM9240 monitoring sequence is started, it cycles sequentially through the measurement of analog inputs and the temperature sensor, while at the same time the fan speed inputs are independently monitored. Measured values from these inputs are stored in value registers. These can be read out over the serial bus, or can be compared with programmed limits stored in the limit registers. The results of out-of-limit comparisons are stored in the interrupt status registers and will generate an interrupt on the $\overline{\text{INT}}$ line (Pin 10).

Any or all of the Interrupt Status Bits can be masked by appropriate programming of the Interrupt Mask Register.

A $\overline{\text{RESET}}$ input/output (Pin 12) is provided. Pulling this pin low will reset all ADM9240 internal registers to default values. The ADM9240 can also be programmed to give a low-going 20 ms reset pulse at this pin.

The ADM9240 contains an on-chip, 8-bit digital-to-analog converter with an output range of zero to 1.25 V (Pin 11). This is typically used to implement a temperature-controlled fan by controlling the speed of a fan dependent upon the temperature measured by the on-chip temperature sensor.

Testing of board level connectivity is simplified by providing a NAND tree test function. The AOUT (Pin 11) also doubles as a NAND test input, while Pin 1 doubles as a NAND tree output.

INTERNAL REGISTERS OF THE ADM9240

A brief description of the ADM9240's principal internal registers is given below. More detailed information on the function of each register is given in Tables V to XVII.

Configuration Register: Provides control and configuration.

Serial Address Register: Stores the serial bus address of the ADM9240.

Address Pointer Register: Contains the address that selects one of the other internal registers. When writing to the ADM9240, the first byte of data is always a register address, which is written to the Address Pointer Register.

Interrupt (INT) Status Registers: Two registers to provide status of each Interrupt event.

Interrupt (INT) Mask Registers: Allow masking of individual Interrupt sources.

Temperature Configuration Register: The configuration of the temperature interrupt is controlled by the lower three bits of this register.

VID/Fan Divisor Registers: The status of the VID0 to VID4 pins of the processor can be written to and read from these registers. Divisor values for fan-speed measurement are also stored in one of these registers.

Value and Limit Registers: The results of analog voltage inputs, temperature and fan speed measurements are stored in these registers, along with their limit values.

Analog Output Register: The code controlling the analog output DAC is stored in this register.

Chassis Intrusion Clear Register: A signal latched on the chassis intrusion pin can be cleared by writing to this register.

SERIAL BUS INTERFACE

Control of the ADM9240 is carried out via the serial bus. The ADM9240 is connected to this bus as a slave device, under the control of a master device, e.g., the PIIX4.

The ADM9240 has a 7-bit serial bus address. When the device is powered up, it will do so with a default serial bus address. The five MSBs of the address are set to 01011, the two LSBs are determined by the logical states of Pin 1 (NTEST_OUT/A0) and Pin 2 (A1) at power-up. These pins have internal 75 kΩ pull-down resistors, so if they are left open-circuit the default address will be 0101100.

The facility to make hardwired changes to A1 and A0 allows the user to avoid conflicts with other devices sharing the same serial bus, for example if more than one ADM9240 is used in a system. Once the ADM9240 has been powered up, the five MSBs of the serial bus address may be changed by writing a 7-bit word to the serial Address Pointer Register (the hardwired values of A0 and A1 cannot be overwritten). Thereafter, the new serial bus address must be used to select the ADM9240, until it is changed again, or the device is powered off.

The serial bus protocol operates as follows:

1. The master initiates data transfer by establishing a START condition, defined as a high-to-low transition on the serial data line SDA while the serial clock line SCL remains high. This indicates that an address/data stream will follow. All slave peripherals connected to the serial bus respond to the START condition, and shift in the next eight bits, consisting of a 7-bit address (MSB first) plus an R/W bit, which determines the direction of the data transfer, i.e., whether data will be written to or read from the slave device.

The peripheral whose address corresponds to the transmitted address responds by pulling the data line low during the low period before the ninth clock pulse, known as the acknowledge bit. All other devices on the bus now remain idle while the selected device waits for data to be read from or written to it. If the R/W bit is a 0, the master will write to the slave device. If the R/W bit is a 1, the master will read from the slave device.

2. Data is sent over the serial bus in sequences of nine clock pulses, eight bits of data followed by an acknowledge bit

from the slave device. Transitions on the data line must occur during the low period of the clock signal and remain stable during the high period, as a low-to-high transition when the clock is high may be interpreted as a STOP signal. The number of data bytes that can be transmitted over the serial bus in a single READ or WRITE operation is limited only by what the master and slave devices can handle.

3. When all data bytes have been read or written, stop conditions are established. In WRITE mode, the master will pull the data line high during the tenth clock pulse to assert a STOP condition. In READ mode, the master device will override the acknowledge bit by pulling the data line high during the low period before the ninth clock pulse. This is known as No Acknowledge. The master will then take the data line low during the low period before the tenth clock pulse, then high during the tenth clock pulse to assert a STOP condition.

Any number of bytes of data may be transferred over the serial bus in one operation, but it is not possible to mix read and write in one operation, because the type of operation is determined at the beginning and cannot subsequently be changed without starting a new operation.

In the case of the ADM9240, write operations contain either one or two bytes, and read operations contain one byte and perform the following functions:

To write data to one of the device data registers or read data from it, the Address Pointer Register must be set so that the correct data register is addressed, then data can be written into that register or read from it. The first byte of a write operation always contains an address that is stored in the Address Pointer Register. If data is to be written to the device, then the write operation contains a second data byte that is written to the register selected by the Address Pointer Register.

This is illustrated in Figure 2a. The device address is sent over the bus followed by R/W set to 0. This is followed by two data bytes. The first data byte is the address of the internal data register to be written to, which is stored in the Address Pointer Register. The second data byte is the data to be written to the internal data register.

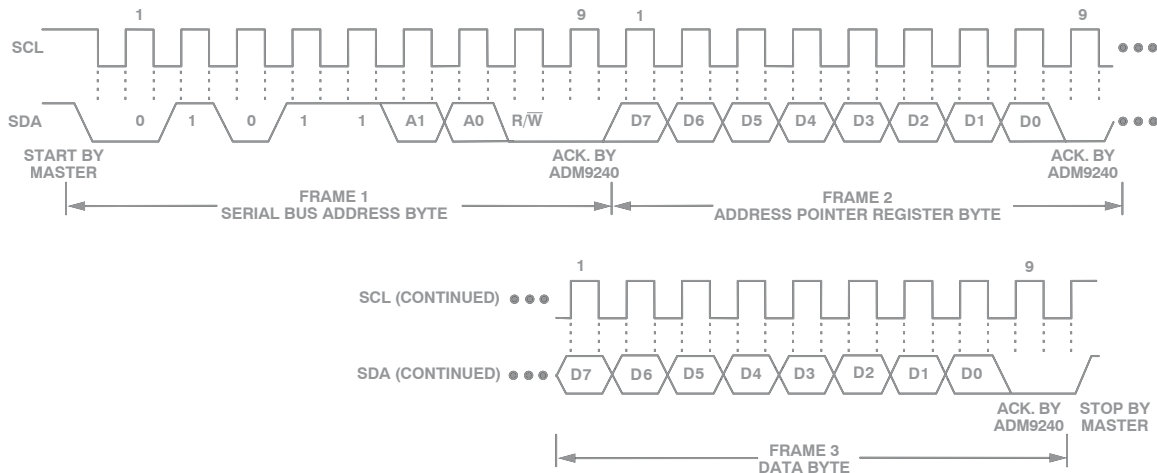

Figure 2a. Writing a Register Address to the Address Pointer Register, then Writing Data to the Selected Register

ADM9240

When reading data from a register there are two possibilities:

1. If the ADM9240's Address Pointer Register value is unknown or not the desired value, it is first necessary to set it to the correct value before data can be read from the desired data register. This is done by performing a write to the ADM9240 as before, but only the data byte containing the register address is sent, as data is not to be written to the register. This is shown in Figure 2b.

A read operation is then performed consisting of the serial bus address, R/\bar{W} bit set to 1, followed by the data byte read from the data register. This is shown in Figure 2c.

2. If the Address Pointer Register is known to be already at the desired address, data can be read from the corresponding data register without first writing to the Address Pointer Register, so Figure 2b can be omitted.

Notes:

1. Although it is possible to read a data byte from a data register without first writing to the Address Pointer Register, if the Address Pointer Register is already at the correct value, it is not possible to write data to a register without writing to the Address Pointer Register, because the first data byte of a write is always written to the Address Pointer Register.

2. In Figures 2a to 2c, the serial bus address is shown as the default value 01011 (A1)(A0), where A1 and A0 are hardwired to either Logic 0 or Logic 1.

ANALOG INPUTS

The ADM9240 has six analog inputs. Four of these are dedicated to monitoring the following power supply voltages: +12 V, +5 V, +3.3 V, +2.5 V.

These inputs are multiplexed into the on-chip, successive approximation, analog-to-digital converter. This has a resolution of ten bits, but only eight bits are used for the voltage measurement and limit comparison. The basic input range of the ADC is 0 V to 2.5 V, and the power supply inputs are scaled by on-chip attenuators such that the ADC produces an output of $3/4 \times$ full scale or 192 decimal, when the input voltage is at its nominal value. The use of on-chip scaling guarantees accuracy and removes the need for precision external resistors.

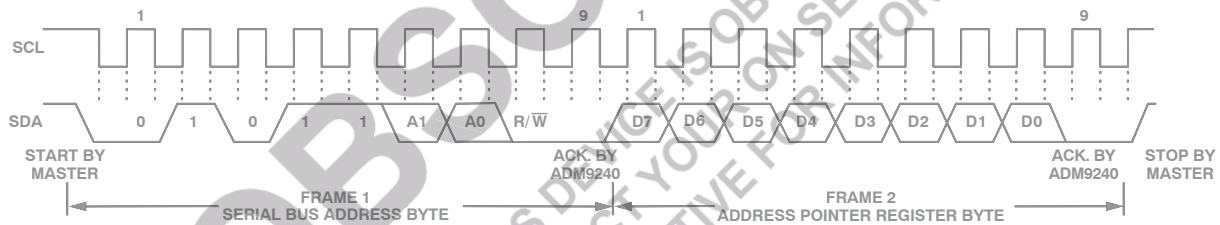

Figure 2b. Writing to the Address Pointer Register only

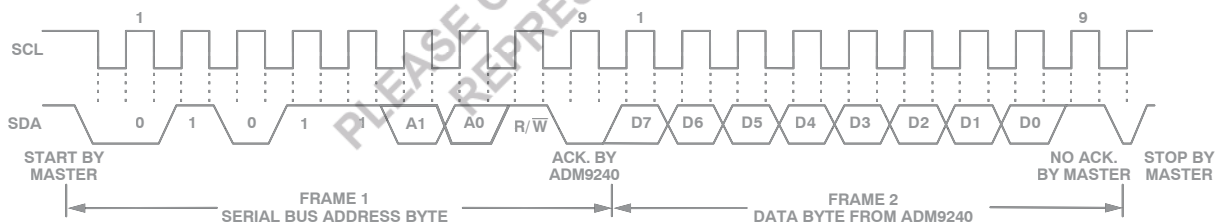

Figure 2c. Reading Data from a Previously Selected Register

The input ranges of the analog inputs are shown in more detail in Table I.

The $+V_{CCP1}$ and $+V_{CCP2}$ inputs are used to measure processor core voltages, and have an input range from 0 V to 3.6 V. If only a single processor core voltage is being monitored, the V_{CCP2} input may be used to monitor the -12 V supply. This is achieved by using a resistive divider network referenced to a known positive dc voltage. This is illustrated in Figure 4.

INPUT CIRCUITS

The internal structure for the analog inputs is shown in Figure 3. Each input circuit consists of an input protection diode, an attenuator, plus a capacitor to form a first order low-pass filter which gives the input immunity to high frequency noise.

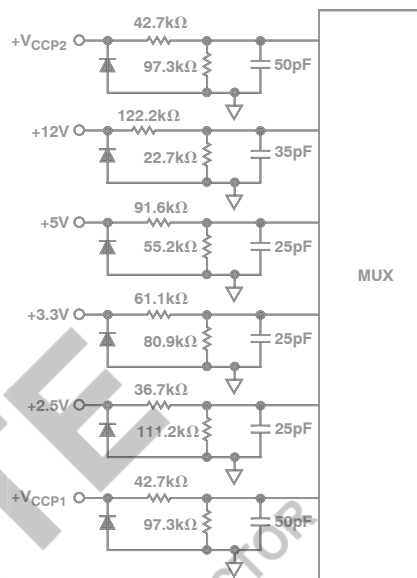

Figure 3. Internal Structure of Analog Inputs

Table I. A/D Output Code vs. V_{IN}

Input Voltage						A/D Output	
$+12 V_{IN}$	$+5 V_{IN}$	$+3.3 V_{IN}$	$+2.5 V_{IN}$	$+V_{CCP1}$	$+V_{CCP2}$	Decimal	Binary
<0.062	<0.026	<0.0172	<0.013	<0.014	<0.014	0	00000000
0.062–0.125	0.026–0.052	0.017–0.034	0.013–0.026	0.014–0.028	0.014–0.028	1	00000001
0.125–0.187	0.052–0.078	0.034–0.052	0.026–0.039	0.028–0.042	0.028–0.042	2	00000010
0.188–0.250	0.078–0.104	0.052–0.069	0.039–0.052	0.042–0.056	0.042–0.056	3	00000011
0.250–0.313	0.104–0.130	0.069–0.086	0.052–0.065	0.056–0.070	0.056–0.070	4	00000100
0.313–0.375	0.130–0.156	0.086–0.103	0.065–0.078	0.070–0.084	0.070–0.084	5	00000101
0.375–0.438	0.156–0.182	0.103–0.120	0.078–0.091	0.084–0.098	0.084–0.098	6	00000110
0.438–0.500	0.182–0.208	0.120–0.138	0.091–0.104	0.098–0.112	0.098–0.112	7	00000111
0.500–0.563	0.208–0.234	0.138–0.155	0.104–0.117	0.112–0.126	0.112–0.126	8	00001000
			1				
			1				
4.000–4.063	1.666–1.692	1.100–1.117	0.833–0.846	0.900–0.914	0.900–0.914	64 (1/4 Scale)	01000000
			1				
			1				
			1				
8.000–8.063	3.330–3.560	2.200–2.217	1.667–1.680	1.800–1.814	1.800–1.814	128 (1/2 Scale)	10000000
			1				
			1				
			1				
12.000–12.063	5.000–5.026	3.300–3.317	2.500–2.513	2.700–2.714	2.700–2.714	192 (3/4 Scale)	11000000
			1				
			1				
			1				
15.313–15.375	6.380–6.406	4.210–4.230	3.190–3.203	3.445–3.459	3.445–3.459	245	11110101
15.375–15.438	6.406–6.432	4.230–4.245	3.203–3.216	3.459–3.473	3.459–3.473	246	11110110
15.438–15.500	6.432–6.458	4.245–4.263	3.216–3.229	3.473–3.487	3.473–3.487	247	11110111
15.500–15.563	6.458–6.484	4.263–4.280	3.229–3.242	3.487–3.501	3.487–3.501	248	11110000
15.563–15.625	6.484–6.510	4.280–4.300	3.242–3.255	3.501–3.515	3.501–3.515	249	11111001
15.625–15.688	6.510–6.536	4.300–4.314	3.255–3.268	3.515–3.529	3.515–3.529	250	11111010
15.688–15.750	6.536–6.562	4.314–4.331	3.268–3.281	3.529–3.543	3.529–3.543	251	11111011
15.750–15.813	6.562–6.588	4.331–4.348	3.281–3.294	3.543–3.558	3.543–3.558	252	11111100
15.813–15.875	6.588–6.615	4.348–4.366	3.294–3.307	3.558–3.572	3.558–3.572	253	11111101
15.875–15.938	6.615–6.640	4.366–4.383	3.307–3.320	3.572–3.586	3.572–3.586	254	11111110
>15.938	>6.640	>4.383	>3.320	>3.586	>3.586	255	11111111

ADM9240

SETTING OTHER INPUT RANGES

If any of the inputs is unused, and there is a requirement for monitoring another power supply such as -12 V, the input range of the unused input can easily be scaled and offset to accommodate this. For example, if only one processor core voltage is to be monitored, the unused V_{CCP} input can be used to monitor another supply voltage.

If the voltage to be monitored is positive, it is simply a matter of using an input with a lower full scale than the voltage to be measured and adding an external input attenuator, but bear in mind that the input resistance ($\approx 140 \text{ k}\Omega$) of the on-chip attenuator will load the external attenuator. This can be accounted for in the calculation, but the values of the on-chip attenuator resistors are not precise and vary with temperature. Therefore, the external attenuator should have a much lower output resistance to minimize the loading. If this is not acceptable, a buffer amplifier can be used.

If the input voltage range is negative, it must first be converted to a positive voltage. The simplest way to do this is simply to attenuate and offset the voltage, as shown in Figure 4, which shows the $+V_{CCP2}$ input scaled to measure a -12 V input. Using the values shown, the input range is zero to -13.5 V, which will accommodate a +12.5% tolerance on the nominal value.

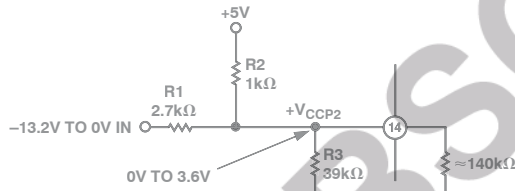

Figure 4. Scaling V_{CCP2} to -12 V (+10%)

The resistor ratios are calculated as follows:

$$R1/R2 = |V_{-}|(max)/V_{+}$$

(to give zero volts at the input for the most negative value of V_{-} . $R2$ has no effect under this condition as the voltage across it is zero)

and:

$$(V_{+} - V_{FS})/V_{FS} = R2/R_P = (R1 \text{ and } R2 \text{ in Parallel})$$

(to give a voltage V_{FS} at the input when V_{-} is zero, where V_{FS} is the normal full-scale voltage of the input used).

This is a simple and cheap solution, but the following points should be noted.

1. Since the input signal is not inverted, an increase in the magnitude of the -12 V supply (going more negative), will cause the input voltage to fall and give a lower output code from the ADC. Conversely, a decrease in the magnitude of the -12 V supply will cause the ADC code to increase. This means that the upper and lower limits will be transposed.
2. Since the offset voltage is derived from the +5 V supply, variations in this supply will affect the ADC code.

It is therefore a good idea to read the value of the +5 V supply and adjust the limits for the -12 V supply accordingly.

The 5 V supply is attenuated by a factor $R_P/(R2+R_P)$, where R_P is the parallel combination of $R1$ and $R3$. An increase in

the 5 V supply increases the ADC input by the $DV \times R_P/(R2+R_P)$, while a decrease in the 5 V supply correspondingly decreases the input to the ADC.

3. The on-chip input attenuators will load the external attenuator, as mentioned earlier.

This technique can be applied to any other unused input. By suitable choice of V_{+} and the input resistors, a variety of negative and/or bipolar input ranges can be obtained.

TEMPERATURE MEASUREMENT SYSTEM

The ADM9240 contains an on-chip bandgap temperature sensor. The on-chip ADC performs 9-bit conversions on the output of this sensor and outputs the temperature data in 9-bit two's complement format, but only the eight most significant bits are used for temperature limit comparison. The full 9-bit temperature data can be obtained by reading the 8 MSBs from the Temperature Value Register (Address 27h) and the LSB from Bit 7 of the Temperature Configuration Register (Address 4Bh).

The format of the temperature data is shown in Table II. Theoretically, the temperature sensor and ADC can measure temperatures from -128°C to +127°C with a resolution of 0.5°C, although temperatures below -40°C and above +125°C are outside the operating temperature range of the device.

Table II. Temperature Data Format

Temperature	Digital Output
-128°C	1 0000 0000
-125°C	1 0000 0110
-100°C	1 0011 1000
-75°C	1 0110 1010
-50°C	1 1001 1100
-25°C	1 1100 1110
-0.5°C	1 1111 1111
0°C	0 0000 0000
+0.5°C	0 0000 0001
+10°C	0 0001 0100
+25°C	0 0011 0010
+50°C	0 0110 0100
+75°C	0 1001 0110
+100°C	0 1100 1000
+125°C	0 1111 1010
+127°C	0 1111 1111

LIMIT VALUES

Limit values for analog measurements are stored in the appropriate limit registers. In the case of voltage measurements, high and low limits can be stored so that an interrupt request will be generated if the measured value goes above or below acceptable values. In the case of temperature, a Hot Temperature Limit can be programmed, and a Hot Temperature Hysteresis Limit, which will usually be some degrees lower. This can be useful as it allows the system to be shut down when the hot limit is exceeded, and automatically restarted when it has cooled down to a safe temperature.

MONITORING CYCLE TIME

The monitoring cycle begins when a one is written to the Start Bit (Bit 0), and a zero to the $\overline{\text{INT_Clear}}$ Bit (Bit 3) of the Configuration Register. $\overline{\text{INT_Enable}}$ (Bit 1) should be set to one to enable the $\overline{\text{INT}}$ output. The ADC measures each analog input in turn, starting with V_{CCP2} and finishing with the on-chip temperature sensor. As each measurement is completed the result is automatically stored in the appropriate value register. This “round-robin” monitoring cycle continues until it is disabled by writing a 0 to Bit 0 of the Configuration Register.

The counter controlling the multiplexer is driven by an on-chip clock of nominally 22.5 kHz, so the entire measurement sequence takes (nominally):

$$44.4 \mu\text{s} \times 7 = 310.8 \mu\text{s}$$

This rapid sampling of the analog inputs ensures a quick response in the event of any input going out of limits, unlike other monitoring chips that employ slower ADCs.

When a monitoring cycle is started, monitoring of the fan speed inputs begins at the same time as monitoring of the analog inputs. However, the two monitoring cycles are not synchronized in any way, and the monitoring cycle time for the fan inputs is dependent on fan speed and much slower than for the analog inputs. For more details see the Fan Speed Measurement section.

INPUT SAFETY

Scaling of the analog inputs is performed on-chip, so external attenuators are normally not required. However, since the power supply voltages will appear directly at the pins, it is advisable to add small external resistors in series with the supply traces to the chip to prevent damaging the traces or power supplies should an accidental short such as a probe connect two power supplies together.

As the resistors will form part of the input attenuators, they will affect the accuracy of the analog measurement if their value is too high. The analog input channels are calibrated assuming an external series resistor of 500 Ω , and the accuracy will remain within specification for any value from zero to 1 k Ω , so a standard 510 Ω resistor is suitable.

The worst such accident would be connecting -12 V to $+12 \text{ V}$ —a total of 24 V difference, with the series resistors this would draw a maximum current of approximately 24 mA.

ANALOG OUTPUT

The ADM9240 has a single analog output from an unsigned 8-bit DAC which produces 0 V–1.25 V. The analog output register defaults to FF during power-on reset, which produces maximum fan speed. The analog output may be amplified and buffered with external circuitry such as an op amp and transistor to provide fan speed control.

A suitable drive circuit is given in Figure 5.

Care must be taken when choosing the op amp to ensure that its input common-mode range and output voltage swing are suitable.

The op amp may be powered from the $+12 \text{ V}$ rail alone or from $\pm 12 \text{ V}$. If it is powered from $+12 \text{ V}$ then the input common-mode range should include ground to accommodate the minimum output voltage of the DAC, and the output voltage should swing below 0.6 V to ensure that the transistor can be turned fully off.

If the op amp is powered from -12 V , precautions such as a clamp diode to ground may be needed to prevent the base-emitter junction of the transistor being reverse-biased in the unlikely event that the output of the op amp should swing negative for any reason.

The positive output swing of the op amp should be as close to $+12 \text{ V}$ as possible so that the maximum voltage can be obtained from the transistor. Even if the op amp swings to the rail, the maximum voltage from the emitter of the transistor will be about 11.4 V. typical values for this condition would be:

$$\text{Gain} = 11.4/1.25 = 9.12 = 1 + R1/R2$$

$$R1 = 82 \text{ k}\Omega, R2 = 10 \text{ k}\Omega \text{ (nearest preferred value)}$$

giving an actual gain of 9.2.

The transistor should have a reasonably high h_{FE} to avoid its base current pulling down the output of the op amp, it must have an I_{CMAX} greater than the maximum fan current and be capable of dissipating power due to the voltage dropped across it when the fan is not operating at full speed. Depending on the fan parameters, some suitable devices would be 2N2219A, 2N3019 or ZTX450.

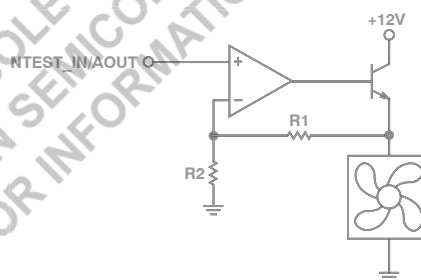

Figure 5. Analog Output Driving Fan

LAYOUT AND GROUNDING

Analog inputs will provide best accuracy when referred to the GNDA pin. A separate, low impedance ground plane for analog ground, which provides a ground point for the voltage dividers and analog components, will provide best performance but is not mandatory.

The power supply bypass, the parallel combination of 10 μF (electrolytic or tantalum) and 0.1 μF (ceramic) bypass capacitors connected between Pin 9 and ground, should also be located as close as possible to the ADM9240.

FAN INPUTS

Two inputs are provided for monitoring the condition of cooling fans. Signal conditioning in the ADM9240 accommodates the slow rise and fall times typical of fan tachometer outputs. The maximum input signal range is 0 to V_{CC} . In the event that these inputs are supplied from fan outputs that exceed 0 to V_{CC} , either resistive attenuation of the fan signal or diode clamping must be included to keep inputs within an acceptable range.

Figures 6a to 6c show circuits for most common fan tachometer outputs.

If the fan tachometer output has a resistive pull-up to V_{CC} it can be connected directly to the fan input, as shown in Figure 6a.

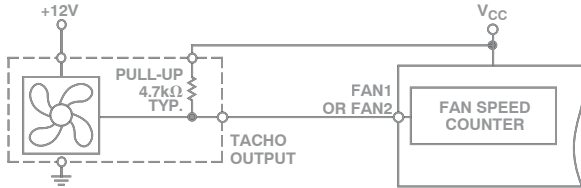

Figure 6a. Fan with Tachometer Pull-Up to $+V_{CC}$

If the fan output has a resistive pull-up to +12 V (or other voltage greater than V_{CC}), the fan output can be clamped with a Zener diode, as shown in Figure 6b. The Zener voltage should be chosen so that it is greater than V_{IH} but less than V_{CC} , allowing for the voltage tolerance of the Zener. A value of about $0.8 \times V_{CC}$ is suitable.

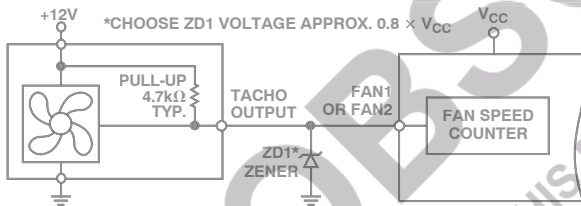

Figure 6b. Fan with Tachometer Pull-Up to Voltage $>V_{CC}$ (e.g., 12 V) Clamped with Zener Diode

If the fan has a strong pull-up (less than 1 k Ω) to +12 V, or a totem-pole output, a series resistor can be added to limit the zener current, as shown in Figure 6c. Alternatively, a resistive attenuator may be used, as shown in Figure 6d.

R_1 and R_2 should be chosen such that:

$$2V < V_{PULL-UP} \times R_2 / (R_{PULL-UP} + R_1 + R_2) < V_{CC}$$

If the value of the pull-up resistor is not known, the value of R_1 and R_2 should be made fairly large, but not so large that the input leakage current will cause a large voltage drop across them.

With a pull-up voltage of 12 V and pull-up resistor less than 1 k Ω , suitable values for R_1 and R_2 would be 100 k Ω and 47 k Ω . This will give a high input voltage of 3.83 V.

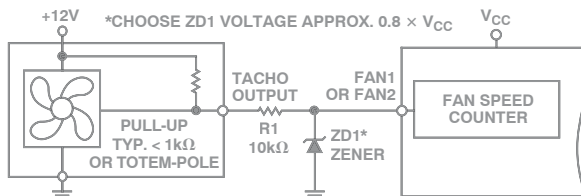

Figure 6c. Fan with Strong Tachometer Pull-Up to $>V_{CC}$ or Totem-Pole Output, Clamped with Zener and Resistor

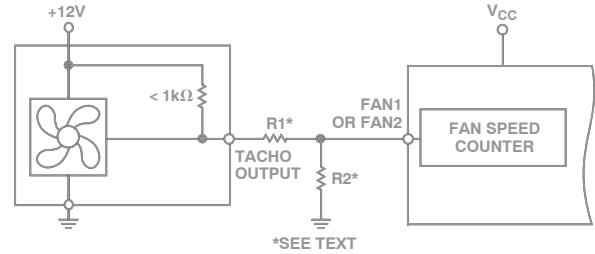

Figure 6d. Fan with Strong Tachometer Pull-Up to $>V_{CC}$ or Totem-Pole Output, Attenuated with R_1/R_2

INPUT CURRENT LIMITING

If the fans are powered while the ADM9240 is unpowered, the inputs of the ADM9240 will try to clamp the fan output voltage. In this case the input current must be limited to less than the maximum value in the Absolute Maximum Ratings table. The pull-up resistor of the fan tachometer output may provide this current limiting but, if its value is too low, it may be necessary to add additional resistance in series with the fan input pins.

FAN SPEED MEASUREMENT

The fan counter does not count the fan tachometer output pulses directly, because the fan speed may be less than 1000 rpm and it would take several seconds to accumulate a reasonably large and accurate count. Instead, the period of the fan revolution is measured by gating an on-chip 22.5 kHz oscillator into the input of an 8-bit counter for two periods of the fan tachometer output, as shown in Figure 7, so the accumulated count is actually proportional to the fan tachometer period and inversely proportional to the fan speed.

The monitoring cycle begins when a one is written to the start bit (Bit 0), and a zero to the $\overline{INT_Clear}$ bit (Bit 3) of the Configuration Register $\overline{INT_Enable}$ (Bit 1) should be set to one to enable the \overline{INT} output. The measurement begins on the rising edge of a fan tachometer pulse, and ends on the next-but-one rising edge. Once the fan speeds have been measured, they will be stored in the Fan Speed Value Registers and can be read at any time. The measurements will be updated as long as the monitoring cycle continues.

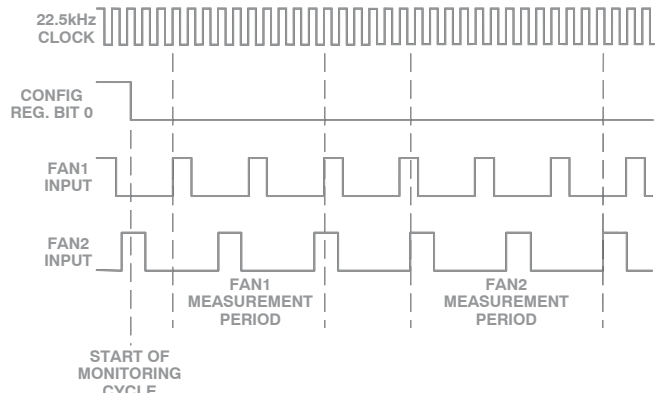

Figure 7. Fan Speed Measurement

To accommodate fans of different speed and/or different numbers of output pulses per revolution, a prescaler (divisor) of 1, 2, 4 or 8 may be added before the counter. The default value is 2, which gives a count of 153 for a fan running at 4400 rpm producing two output pulses per revolution.

The count is calculated by the equation:

$$\text{Count} = (22.5 \times 10^3 \times 60) / (\text{rpm} \times \text{Divisor})$$

For constant speed fans, fan failure is normally considered to have occurred when the speed drops below 70% of nominal, which would correspond to a count of 219. Full scale (255) would be reached if the fan speed fell to 60% of its nominal value. For temperature controlled variable speed fans the situation will be different.

Table III shows the relationship between fan speed and time per revolution at 60%, 70% and 100% of nominal rpm for fan speeds of 1100 rpm, 2200 rpm, 4400 rpm and 8800 rpm, and the divisor that would be used for each of these fans, based on two tach pulses per revolution.

Table III. Fan Speeds and Divisors

Divisor	Nominal rpm	Time per 70% Rev		Time per 60% Rev		Time per 60% Rev (ms)
		(ms)	rpm	(ms)	rpm	
1	8800	6.82	6160	9.74	5280	11.36
2	4400	13.64	3080	19.48	2640	22.73
4	2200	27.27	1540	38.96	1320	45.45
8	1100	54.54	770	77.92	660	90.9

Note that Fan 1 and Fan 2 Divisors are programmed into Bits 4 to 7 of the VID0-VID3/Fan Divisor Register.

LIMIT VALUES

Fans in general will not overspeed if run from the correct voltage, so the failure condition of interest is underspeed due to electrical or mechanical failure. For this reason only low speed limits are programmed into the limit registers for the fans. It should be noted that, since fan period rather than speed is being measured, a fan failure interrupt will occur when the measurement exceeds the limit value.

MONITORING CYCLE TIME

The monitoring cycle time depends on the fan speed and number of tach output pulses per revolution. Two complete periods of the fan tach output (three rising edges) are required for each fan measurement. Therefore, if the start of a fan measurement just misses a rising edge, the measurement can take almost three tach periods. In order to read a valid result from the fan value registers, the total monitoring time allowed after starting the monitoring cycle should therefore be three tach periods of FAN1 plus three tach periods of FAN2 at the lowest normal fan speed.

Although the fan monitoring cycle and the analog input monitoring cycle are started together, they are not synchronized in any other way.

FAN MANUFACTURERS

Manufacturers of cooling fans with tachometer outputs are listed below:

NMB Tech
9730 Independence Ave.
Chatsworth, California 91311
818-341-3355
818-341-8207

Model	Frame Size	Airflow CFM
2408NL	2.36 in sq. × 0.79 in (60 mm sq. × 20 mm)	9–16
2410ML	2.36 in sq. × 0.98 in (60 mm sq. × 25 mm)	14–25
3108NL	3.15 in sq. × 0.79 in (80 mm sq. × 20 mm)	25–42
3110KL	3.15 in sq. × 0.98 in (80 mm sq. × 25 mm)	25–40

Mechatronix Inc.
P.O. Box 613
Preston, WA 98050
800-453-4569
Models—Various sizes available with tach output option.

Sanyo Denki/Keymarc Electronics
468 Amapola Ave.
Torrance, CA 90501
310-783-5400
Models—109P Series

CHASSIS INTRUSION INPUT

The Chassis Intrusion (CI) input is an active high input/open-drain output intended for detection and signalling of unauthorized tampering with the system. An external circuit powered from the system's CMOS backup battery is used to detect and latch a chassis intrusion event, whether the system is powered up or not. Once a chassis intrusion has been detected and latched, the CI input will generate an interrupt when the system is powered up.

The actual detection of chassis intrusion is performed by an external circuit that will, for example, detect when the cover has been removed. A wide variety of techniques may be used for the detection:

- Microswitch that opens or closes when the cover is removed.
- Reed switch operated by magnet fixed to the cover.
- Hall-effect switch operated by magnet fixed to the cover.
- Phototransistor that detects light when cover is removed.

The chassis intrusion interrupt will remain asserted until the external detection circuit is reset. This can be achieved by setting Bit 6 of the Configuration Register, or Bit 7 of the Chassis Intrusion Clear Register to one, which will cause the CI pin to be pulled low for at least 20 ms. These register bits are self-clearing.

ADM9240

The chassis intrusion circuit should be designed so that it can be reset by pulling its output low. A suitable chassis intrusion circuit using a phototransistor is shown in Figure 8. Light falling on the phototransistor when the PC cover is removed will cause it to turn on and pull up the input of N1, thus setting the latch N3/N4. After the cover is replaced, a low reset on the CI output will pull down the input of N4, resetting the latch.

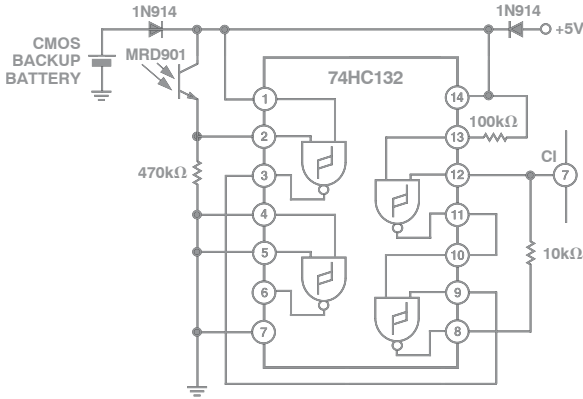

Figure 8a. Chassis Intrusion Detector and Latch

The Chassis Intrusion input can also be used for other types of alarm input. Figure 8b shows a temperature alarm circuit using an AD22105 temperature switch sensor. This produces a low-going output when the preset temperature is exceeded, so the output is inverted by Q1 to make it compatible with the CI input. Q1 can be almost any small-signal NPN transistor, or a TTL or CMOS inverter gate may be used if one is available. See the AD22105 data sheet for information on selecting R_{SET} .

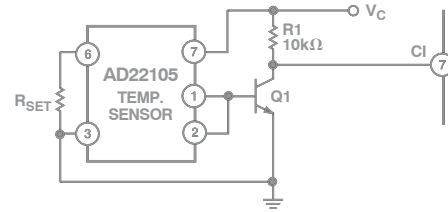

Figure 8b. Using the CI Input with a Temperature Sensor

Note: The chassis intrusion input does not have a protective clamp diode to V_{CC} , as this could pull down the chassis intrusion latch and reset it when the ADM9240 was powered down.

THE ADM9240 INTERRUPT STRUCTURE

The Interrupt Structure of the ADM9240 is shown in Figure 9. As each measurement value is obtained and stored in the appropriate value register, the value and the limits from the corresponding limit registers are fed to the high and low limit comparators. The result of each comparison (1 = out of limit, 0 = in limit) is routed to the corresponding bit input of the Interrupt Status Registers via a data demultiplexer and used to set that bit high or low as appropriate.

The Interrupt Mask Registers have bits corresponding to each of the Interrupt Status Register Bits. Setting an Interrupt Mask Bit high forces the corresponding Status Bit output low, while setting an Interrupt Mask Bit low allows the corresponding Status Bit to be asserted. After masking, the status bits are all ORed together to produce the INT output, which will pull low if any unmasked status bit goes high, i.e., when any measured value goes out of limit.

The \overline{INT} output is enabled when Bit 1 of the Configuration Register (INT_Enable) is high, and Bit 3 ($\overline{INT_Clear}$) is low.

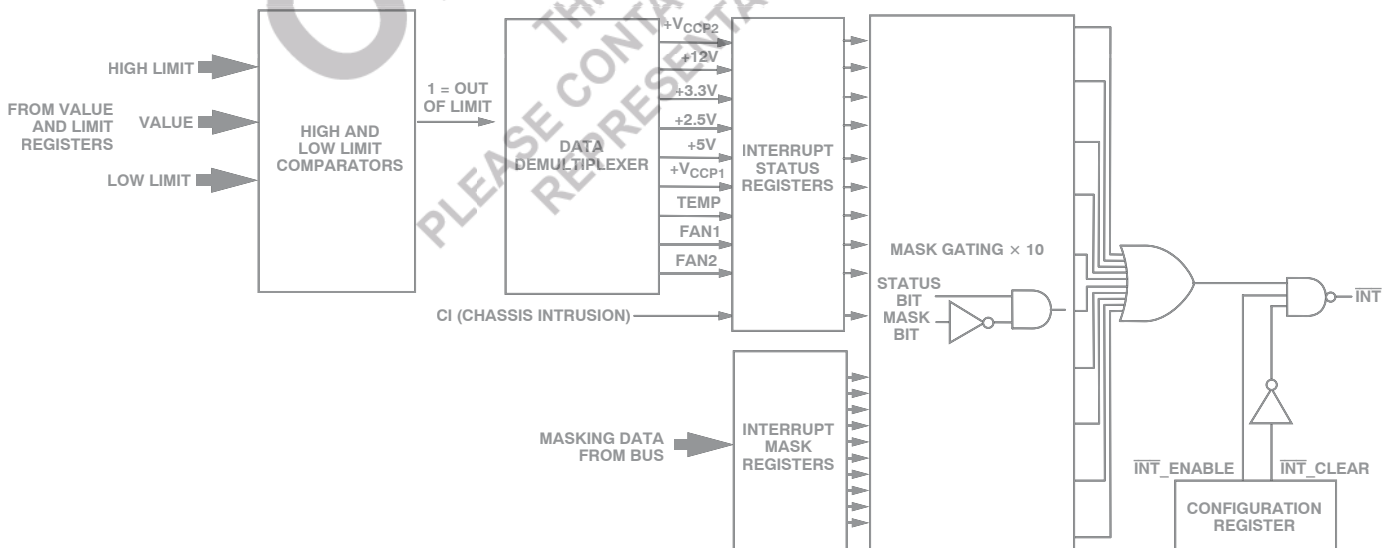

Figure 9. Interrupt Register Structure

INTERRUPT CLEARING

Reading an Interrupt Status Register will output the contents of the Register, then clear it. It will remain cleared until the monitoring cycle updates it, so the next read operation should not be performed on the register until this has happened, or the result will be invalid. The time taken for a complete monitoring cycle is mainly dependent on the time taken to measure the fan speeds, as described earlier.

The $\overline{\text{INT}}$ output is cleared with the $\overline{\text{INT}}$ _Clear bit, which is Bit 3 of the Configuration Register, without affecting the contents of the Interrupt (INT) Status Registers. When this bit is high, the ADM9240 monitoring loop will stop. It will resume when the bit is low.

TEMPERATURE INTERRUPT MODES

As mentioned earlier, two limit values can be programmed for the temperature measurement, a Hot Temperature Limit (T_{HOT}), and a Hot Temperature Hysteresis Limit (T_{HOTHYST}), which is normally some degrees lower.

The interrupt function of the temperature sensor differs from the interrupt operation of the other inputs in that there are three interrupt modes, called “One-Time Interrupt” mode, “Default Interrupt” mode and “Comparator” mode.

DEFAULT INTERRUPT MODE

Exceeding T_{HOT} causes an Interrupt that will remain active indefinitely until reset by reading Interrupt Status Register 1 or cleared by the $\overline{\text{INT}}$ _Clear bit in the Configuration register. Once an Interrupt event has occurred by crossing T_{HOT} , then reset, an Interrupt will occur again once the next temperature conversion has completed. The interrupts will continue to occur in this manner until the temperature goes below T_{HOTHYST} . Operation in the default interrupt mode is illustrated in Figure 10. For clarity, in this illustration the interval between read operations is shown as considerably longer than the monitoring cycle time, so that the interrupt is always reasserted after being reset, before the next read operation occurs.

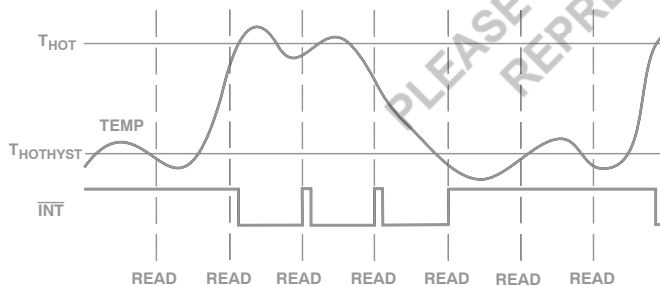

Figure 10. Temperature $\overline{\text{INT}}$ Output in Default Interrupt Mode

ONE-TIME INTERRUPT MODE

Exceeding T_{HOT} causes an Interrupt that will remain active indefinitely until reset by reading Interrupt Status Register 1 or cleared by the $\overline{\text{INT}}$ _Clear bit in the Configuration Register. Once an Interrupt event has occurred by crossing T_{HOT} , then reset, an Interrupt will not occur again until the temperature

goes below T_{HOTHYST} . Operation in the one-time interrupt mode is illustrated in Figure 11. Again, the interval between read operations is shown as being longer than the monitoring cycle time.

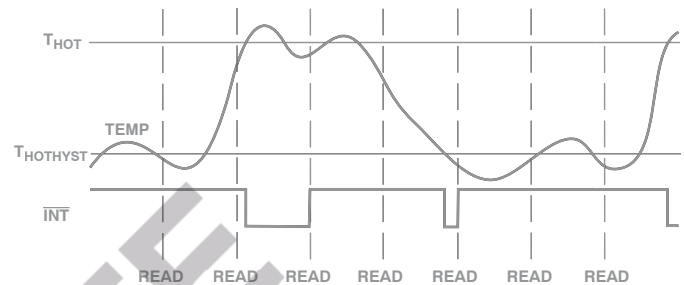

Figure 11. $\overline{\text{INT}}$ Output in One-Time Interrupt Mode

COMPARATOR MODE

Exceeding T_{HOT} causes the $\overline{\text{INT}}$ output to go Low. $\overline{\text{INT}}$ will remain Low until the temperature goes below T_{HOT} . Once the temperature goes below T_{HOT} , $\overline{\text{INT}}$ will go High. T_{HOTHYST} is ignored. In other words, Comparator Mode operates like a thermostat with no hysteresis. Operation in the comparator mode is illustrated in Figure 12.

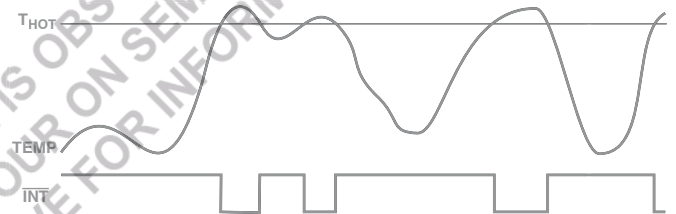

Figure 12. $\overline{\text{INT}}$ Output in Comparator Mode

RESET INPUT/OUTPUT

$\overline{\text{RESET}}$ (Pin 12) is an I/O pin that can function as an open-drain output, providing a low going 20 ms output pulse when Bit 4 of the Configuration Register is set to 1, provided the reset function has first been enabled by setting Bit 7 of Interrupt Mask Register #2 to 1. The bit is automatically cleared when the reset pulse is output. Pin 11 can also function as a $\overline{\text{RESET}}$ input by pulling this pin low to reset the internal registers of the ADM9240 to default values. Only those registers that have power on default values as listed in Table VI are affected by this function. The DAC register, Value and Limit Registers are not affected.

NAND TREE TESTS

A NAND tree is provided in the ADM9240 for Automated Test Equipment (ATE) board level connectivity testing. The device is placed into NAND Test Mode by powering up with Pin 11 held high. This pin is sampled automatically after power-up and if it connected high, then the NAND test mode is invoked.

In NAND test mode, all digital inputs may be tested as illustrated below. A0/NTEST_OUT will become the NAND tree output pin. To perform a NAND tree test, all pins included in the NAND tree should be driven high.

ADM9240

The structure of the NAND tree is shown in Figure 13.

Beginning with A1 and working clockwise around the chip, each pin can be toggled and a resulting toggle can be observed on NTEST_OUT/A0.

Allow for a typical propagation delay of 500 ns.

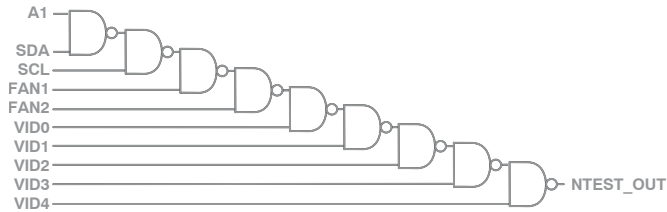

Figure 13. NAND Tree

Note: If any of the inputs shown in Figure 9 are unused, they should not be connected directly to ground, but via a resistor such as 10 kΩ. This will allow the ATE (Automatic Test Equipment) to drive every input high so that the NAND tree test can be properly carried out.

USING THE ADM9240

POWER-ON RESET

When power is first applied, the ADM9240 performs a “power-on reset” on several of its registers. Registers whose power-on values are not shown have power-on conditions that are indeterminate (this includes the Value and Limit Registers). The ADC is inactive. In most applications, usually the first action after power-on would be to write limits into the Limit Registers.

Power-on reset clears or initializes the following registers (the initialized values are shown in Table VI:

- Configuration Register
- Serial Address Register
- Interrupt (INT) Status Registers #1 and #2
- Interrupt (INT) Mask Registers #1 and #2
- VID /Fan Divisor Register
- VID4 Register
- Chassis Intrusion Clear Register
- Temperature Configuration Register
- Test Register
- Compatibility Register
- Analog Output Register

INITIALIZATION

Configuration Register INITIALIZATION performs a similar, but not identical, function to power-on reset. The Test Register and Analog Output Register are not initialized.

Configuration Register INITIALIZATION is accomplished by setting Bit 7 of the Configuration Register high. This bit automatically clears after being set.

Using the Configuration Register

Control of the ADM9240 is provided through the Configuration Register. The ADC is stopped upon power-up, and the $\overline{\text{INT_Clear}}$ signal is asserted, clearing the $\overline{\text{INT}}$ output. The Configuration Register is used to start and stop the ADM9240; enable or disable interrupt outputs and modes, and provide the initialization function described above.

Bit 0 of the Configuration Register controls the monitoring loop of the ADM9240. Setting Bit 0 low stops the monitoring loop and puts the ADM9240 into a low power mode thereby reducing power consumption. Serial bus communication is still possible with any register in the ADM9240 while in low power mode. Setting Bit 0 high starts the monitoring loop.

Bit 1 of the Configuration Register enables or disables the $\overline{\text{INT}}$ Interrupt output. Setting Bit 1 high enables the $\overline{\text{INT}}$ output, setting Bit 1 low disables the output.

Bit 3 of the Configuration Register is used to clear the $\overline{\text{INT}}$ interrupt output when set high. The ADM9240 monitoring function will stop until Bit 3 is set low. Interrupt Status Register contents will not be affected.

Bit 4 of the Configuration Register is used to initiate a minimum 20 ms $\overline{\text{RESET}}$ signal on the $\overline{\text{RESET}}$ output if the function is enabled by Bit 7 in Register 44.

Bit 6 of the Configuration Register is used to reset the Chassis Intrusion (CI) output pin when set high.

Bit 7 of the Configuration Register is used to start a Configuration Register Initialization when taken high.

STARTING CONVERSION

The monitoring function (analog inputs, temperature and fan speeds) in the ADM9240 is started by writing to the Configuration Register and setting Start (Bit 0), high, $\overline{\text{INT_Enable}}$ (Bit 1) high and $\overline{\text{INT_Clear}}$ (Bit 3) low. Apart from initially starting together, the analog measurements and fan speed measurements proceed independently and are not synchronized in any way.

The analog measurements will be completed in no more than 353 μs . The time taken to complete the fan speed measurements depends on the fan speed and the number of tachometer pulses per revolution.

Once the measurements have been completed, the results can be read from the Value Registers at any time.

Table IV shows the measurement sequence for the analog inputs.

Table IV. Measurement Sequence

Measurement #	Parameter
1	Analog +V _{CCP2}
2	Analog +12 V _{IN}
3	Analog +5 V _{IN}
4	Analog +3.3 V _{IN}
5	Analog +2.5 V _{IN}
6	Analog +V _{CCP1}
7	Temperature Reading

LOW POWER AND SHUTDOWN MODE

The ADM9240 can be placed in a low power mode by setting Bit 0 of the Configuration register to 0. This disables the internal ADC. Full shutdown mode may then be achieved by setting Bit 0 of the Test Register to 1. This turns off the analog output and stops the monitoring cycle, if running, but it does not affect the condition of any of the registers. The device will return to its previous state when this bit is reset to zero.

APPLICATION CIRCUIT

Figure 14 shows a generic application circuit using the AD9240. The analog monitoring inputs are connected to the power supplies including two processor core voltage inputs. The VID inputs are connected to the processor voltage ID pins. There are two tachometer inputs from fans, and the analog output is used to control the speed of a third fan. A chassis intrusion latch with an opto-sensor is connected to the CI input. Of course, in an actual application, every input and output may not be used, in which case unused analog and digital inputs should be tied to analog or digital ground as appropriate.

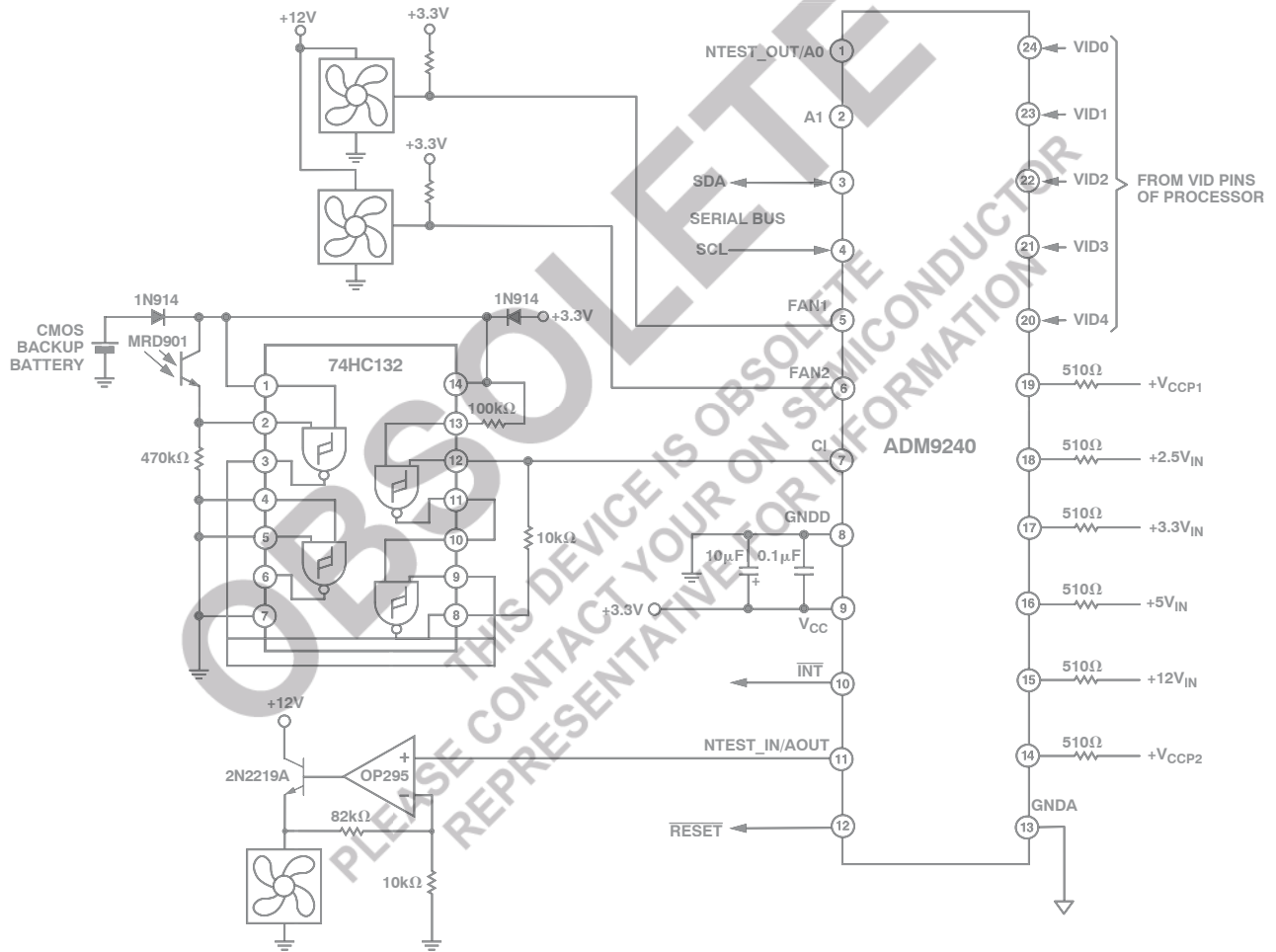

Figure 14. Application Circuit

Table V. Address Pointer Register

Bit	Name	R/W	Description
7-0	Address Pointer	Write	Address of ADM9240 Registers. See the tables below for detail.

Table VI. List of Registers

Address	Description	Power on Value	Notes A7-A0 (Binary Bit 7-0)
15h	Test Register	0000 0000	Setting Bit 0 of this register to 1 selects shutdown mode. Caution: Do Not write to any other bits in this register.
19h	Programmed Value of Analog Output	1111 1111	
20h	+2.5 V Measured Value	Indeterminate	Read Only
21h	+V _{CCP1} Measured Value	Indeterminate	Read Only
22h	+3.3 V Measured Value	Indeterminate	Read Only
23h	+5 V Measured Value	Indeterminate	Read Only
24h	+12 V Measured Value	Indeterminate	Read Only
25h	V _{CCP2} Measured Value	Indeterminate	Read Only
26h	Reserved	Indeterminate	
27h	Temperature Reading	Indeterminate	Read Only
28h	FAN1 Reading	Indeterminate	Read Only
29h	FAN2 Reading	Indeterminate	Read Only
2Ah	Reserved	Indeterminate	
2Bh	+2.5 V High Limit	Indeterminate	
2Ch	+2.5 V Low Limit	Indeterminate	
2Dh	+V _{CCP1} High Limit	Indeterminate	
2Eh	+V _{CCP1} Low Limit	Indeterminate	
2Fh	+3.3 V High Limit	Indeterminate	
30h	+3.3 V Low Limit	Indeterminate	
31h	+5 V High Limit	Indeterminate	
32h	+5 V Low Limit	Indeterminate	
33h	+12 V High Limit	Indeterminate	
34h	+12V Low Limit	Indeterminate	
35h	V _{CCP2} High Limit	Indeterminate	
36h	V _{CCP2} Low Limit	Indeterminate	
37h	Reserved	Indeterminate	
38h	Reserved	Indeterminate	
39h	Hot Temperature Limit (High)	Indeterminate	
3Ah	Hot Temperature Hysteresis Limit (Low)	Indeterminate	
3Bh	FAN1 Fan Count Limit	Indeterminate	
3Ch	FAN2 Fan Count Limit	Indeterminate	
3Dh	Reserved	Indeterminate	
3Eh	Company ID Number	0010 0011	This location will contain the company identification number (Read Only).
3Fh	Revision Number	Die Revision	This location will contain the revision number of the part. (Read Only).
40h	Configuration Register	0000 1000	See Table VII
41h	Interrupt $\overline{\text{INT}}$ Status Register 1	0000 0000	See Table VIII
42h	Interrupt $\overline{\text{INT}}$ Status Register 2	0000 0000	See Table IX
43h	$\overline{\text{INT}}$ Mask Register 1	0000 0000	See Table X
44h	$\overline{\text{INT}}$ Mask Register 2	0000 0000	See Table XI
45h	Compatibility Register	0000 0000	See Table XII
46h	Chassis Intrusion Clear Register	0000 0000	See Table XIII
47h	VID0-3/Fan Divisor Register	0101 (VID3-VID0)	See Table XIV
48h	Serial Address Register	0010 11(A1)(A0)	See Table XV
49h	VID4 Register	1000 000(VID4)	See Table XVI
4Bh	Temperature Configuration Register	0000 0001	See Table XVII

Table VII. Register 40h, Configuration Register (Power-On Default = 08h)

Bit	Name	R/W	Description
0	START	R/W	Logic 1 enables startup of ADM9240, Logic 0 places it in standby mode. Caution: the outputs of the Interrupt pins will not be cleared if the user writes a zero to this location after an interrupt has occurred (see "INT_Clear" bit). At startup, limit checking functions and scanning begins. Note, all high and low limits should be set into the ADM9240 prior to turning on this bit. (Power-Up Default = 0.)
1	INT_Enable	R/W	Logic 1 enables the INT output. 1 = Enabled 0 = Disabled (Power-Up Default = 0).
2	Reserved		Default = 0.
3	INT_Clear	R/W	During Interrupt Service Routine (ISR) this bit is asserted Logic 1 to clear INT output without affecting the contents of the Interrupt Status Register. The device will stop monitoring. It will resume upon clearing of this bit. (Power-Up Default = 1.)
4	RESET	R/W	Creates a RESET (Active Low) signal for 20 ms minimum (Power-Up Default = 0). This bit is cleared once the pulse goes active.
5	Reserved	R/W	Default = 0.
6	CI_Reset	R/W	A "1" outputs a minimum 20 ms active low pulse on the Chassis Intrusion pin. (Power-Up Default = 0.) (Note: This bit performs the same function as Bit 7 in Register 46h).
7	Initialization	R/W	Logic 1 restores power-up default values to the Configuration register, Interrupt status registers, Interrupt Mask Registers, Fan Divisor Register and the Temperature Configuration Register. This bit automatically clears itself since the power-on default is zero.

Table VIII. Register 41h, Interrupt Status Register 1 (Power-On Default = 00h)

Bit	Name	R/W	Description
0	+2.5 V_Error	Read Only	A "1" indicates a high or low limit has been exceeded.
1	V _{CCP} _Error	Read Only	A "1" indicates a high or low limit has been exceeded.
2	+3.3 V_Error	Read Only	A "1" indicates a high or low limit has been exceeded.
3	+5 V_Error	Read Only	A "1" indicates a high or low limit has been exceeded.
4	Temp_Error	Read Only	A "1" indicates that a temperature interrupt has been set.
5	Reserved	Read Only	Undefined.
6	FAN1_Error	Read Only	A "1" indicates that a fan count limit has been exceeded.
7	FAN2_Error	Read Only	A "1" indicates that a fan count limit has been exceeded.

Table IX. Register 42h, Interrupt Status Register 2 (Power-On Default = 00h)

Bit	Name	R/W	Description
0	+12 V_Error	Read Only	A "1" indicates a high or low limit has been exceeded.
1	V _{CCP2} _Error	Read Only	A "1" indicates a high or low limit has been exceeded.
2	Reserved	Read Only	Undefined.
3	Reserved	Read Only	Undefined.
4	Chassis_Error	Read Only	A "1" indicates chassis intrusion has gone high.
5	Reserved	Read Only	Undefined.
6	Reserved	Read Only	Undefined.
7	Reserved	Read Only	Undefined.

Note: Any time the STATUS Register is read out, the conditions (i.e., Register) that are read are automatically reset. In the case of the channel priority indication, if two or more channels were out of limits, another indication would automatically be generated if it were not handled during the ISR. In the Mask Register, the errant voltage interrupt may be disabled until the operator has time to clear the errant condition or set the limit higher/lower.

Table X. Register 43h, $\overline{\text{INT}}$ Interrupt Mask Register 1 (Power-On Default = 00h)

Bit	Name	R/ $\overline{\text{W}}$	Description
0	+2.5 V	Read/ $\overline{\text{Write}}$	A "1" disables the corresponding interrupt status bit for $\overline{\text{INT}}$ interrupt.
1	+V _{CCP1}	Read/ $\overline{\text{Write}}$	A "1" disables the corresponding interrupt status bit for $\overline{\text{INT}}$ interrupt.
2	+3.3 V	Read/ $\overline{\text{Write}}$	A "1" disables the corresponding interrupt status bit for $\overline{\text{INT}}$ interrupt.
3	+5 V	Read/ $\overline{\text{Write}}$	A "1" disables the corresponding interrupt status bit for $\overline{\text{INT}}$ interrupt.
4	Temp	Read/ $\overline{\text{Write}}$	A "1" disables the corresponding interrupt status bit for $\overline{\text{INT}}$ interrupt.
5	Reserved	Read/ $\overline{\text{Write}}$	Power-On Default = 0.
6	FAN1	Read/ $\overline{\text{Write}}$	A "1" disables the corresponding interrupt status bit for $\overline{\text{INT}}$ interrupt.
7	FAN2	Read/ $\overline{\text{Write}}$	A "1" disables the corresponding interrupt status bit for $\overline{\text{INT}}$ interrupt.

Table XI. Register 44h, $\overline{\text{INT}}$ Mask Register 2 (Power-On Default = 00h)

Bit	Name	R/ $\overline{\text{W}}$	Description
0	+12 V	Read/ $\overline{\text{Write}}$	A "1" disables the corresponding interrupt status bit for $\overline{\text{INT}}$ interrupt.
1	V _{CCP2}	Read/ $\overline{\text{Write}}$	A "1" disables the corresponding interrupt status bit for $\overline{\text{INT}}$ interrupt.
2	Reserved	Read/ $\overline{\text{Write}}$	Power-up default set to Low.
3	Reserved	Read/ $\overline{\text{Write}}$	Power-up default set to Low.
4	CI	Read/ $\overline{\text{Write}}$	A "1" disables the corresponding interrupt status bit for $\overline{\text{INT}}$ interrupt.
5	Reserved	Read/ $\overline{\text{Write}}$	Undefined.
6	Reserved	Read/ $\overline{\text{Write}}$	Undefined.
7	$\overline{\text{RESET}}$ Enable	Read/ $\overline{\text{Write}}$	A "1" enables the $\overline{\text{RESET}}$ function in the configuration register.

Table XII. Register 45h, Reserved Compatibility (Power-On Default = 00h)

Bit	Name	R/ $\overline{\text{W}}$	Description
0-7	Reserved	Read/ $\overline{\text{Write}}$	Reserved for Compatibility.

Table XIII. Register 46h, Chassis Intrusion Clear (Power-On Default = 00h)

Bit	Name	R/ $\overline{\text{W}}$	Description
0-6	Reserved	Read/ $\overline{\text{Write}}$	Undefined (Power On Default = 00h)
7	Chassis Int. Clear	Read/ $\overline{\text{Write}}$	A "1" outputs a minimum 20 ms active low pulse on the chassis intrusion pin. The register bit clears itself after the pulse has been output.

Table XIV. Register 47h, VID0-3/Fan Divisor Register (Power-On Default 0101(VID3-VID0))

Bit	Name	R/ $\overline{\text{W}}$	Description
0-3	VID	Read	The VID[3:0] inputs from processor core power supplies to indicate the operating voltage (e.g., 1.3 V to 3.5 V).
4-5	FAN1 Divisor	Read/ $\overline{\text{Write}}$	Sets Counter Prescaler for FAN1 Speed Measurement <5:4> = 00 - Divide by 1 <5:4> = 01 - Divide by 2 <5:4> = 10 - Divide by 4 <5:4> = 11 - Divide by 8
6-7	FAN2 Divisor	Read/ $\overline{\text{Write}}$	Sets Counter Prescaler for FAN2 Speed Measurement <7:6> = 00 - Divide by 1 <7:6> = 01 - Divide by 2 <7:6> = 10 - Divide by 4 <7:6> = 11 - Divide by 8

Table XV. Register 48h, Serial Address Register (Power-On Default = 0010 11(A1)(A0))

Bit	Name	R/W	Description
0-6	Serial Bus Address	Read/ $\overline{\text{Write}}$	Serial Bus Address (Bits 0 and 1 are Set by A0, A1 and Bit 7 is Read Only)

Table XVI. Register 49h, VID 4/Device ID Register (Power-On Default 1000000(VID4))

Bit	Name	R/W	Description
0	VID4	Read	VID4 Input from Pentium®
1-7	Reserved	Read/ $\overline{\text{Write}}$	

Table XVII. Register 4Bh, Temperature Configuration Register (Power-On Default = 01h)

Bit	Name	R/W	Description
0-1	Hot Temperature Interrupt Mode Select Bits	Read/ $\overline{\text{Write}}$	<p>If Bit 0 and Bit 1 of this register are both zero or one, this selects the default interrupt mode, which gives the user an interrupt if the temperature goes above the hot limit. The interrupt will be cleared once the status register is read, but it will again be generated when the next conversion has completed. It will continue to do so until the temperature goes below the hysteresis limit.</p> <p>A 0 on Bit 1 and a 1 on Bit 0 selects the one-time interrupt mode, which gives the user an interrupt when the temperature goes above the hot limit. The interrupt will be cleared once the status register is read. Another interrupt will not be generated until the temperature first goes below the hysteresis limit. No more interrupts will be generated until the temperature again goes above the hot limit. The corresponding bit will be cleared in the status register every time it is read, but may not set again when the next conversion is done. Note that this is the power-up default mode.</p> <p>A 1 on Bit 1 and a 0 on Bit 0 selects the comparator mode. This gives an $\overline{\text{INT}}$ when the temperature exceeds the hot limit. This $\overline{\text{INT}}$ remains active until the temperature goes below the hot limit (no hysteresis), when the $\overline{\text{INT}}$ will become inactive.</p>
2-6	Reserved	Read/ $\overline{\text{Write}}$	Default = 00000
7	Temp	Read only	LSB of Temperature Reading = 0.5°C

OUTLINE DIMENSIONS

Dimensions shown in inches and (mm).

24-Lead TSSOP (RU-24)

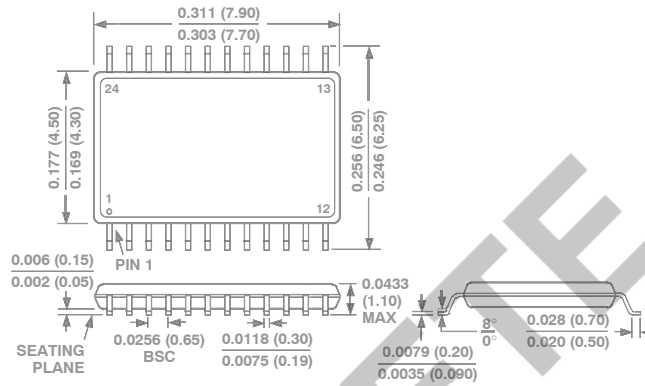

ORDERING GUIDE

Model	Temperature Range	Package Description	Package Option
ADM9240ARU	-40°C to +125°C	24-Lead TSSOP	RU-24
ADM9240ARU-REEL	-40°C to +125°C	24-Lead TSSOP	RU-24
ADM9240ARU-REEL7	-40°C to +125°C	24-Lead TSSOP	RU-24
ADM9240ARUZ ¹	-40°C to +125°C	24-Lead TSSOP	RU-24
ADM9240ARUZ-REEL ¹	-40°C to +125°C	24-Lead TSSOP	RU-24
ADM9240ARUZ-R7 ¹	-40°C to +125°C	24-Lead TSSOP	RU-24

¹Z = Pb-Free part

ON Semiconductor and the ON logo are registered trademarks of Semiconductor Components Industries, LLC (SCILLC). SCILLC reserves the right to make changes without further notice to any products herein. SCILLC makes no warranty, representation or guarantee regarding the suitability of its products for any particular purpose, nor does SCILLC assume any liability arising out of the application or use of any product or circuit, and specifically disclaims any and all liability, including without limitation special, consequential or incidental damages. "Typical" parameters which may be provided in SCILLC data sheets and/or specifications can and do vary in different applications and actual performance may vary over time. All operating parameters, including "Typicals" must be validated for each customer application by customer's technical experts. SCILLC does not convey any license under its patent rights nor the rights of others. SCILLC products are not designed, intended, or authorized for use as components in systems intended for surgical implant into the body, or other applications intended to support or sustain life, or for any other application in which the failure of the SCILLC product could create a situation where personal injury or death may occur. Should Buyer purchase or use SCILLC products for any such unintended or unauthorized application, Buyer shall indemnify and hold SCILLC and its officers, employees, subsidiaries, affiliates, and distributors harmless against all claims, costs, damages, and expenses, and reasonable attorney fees arising out of, directly or indirectly, any claim of personal injury or death associated with such unintended or unauthorized use, even if such claim alleges that SCILLC was negligent regarding the design or manufacture of the part. SCILLC is an Equal Opportunity/Affirmative Action Employer. This literature is subject to all applicable copyright laws and is not for resale in any manner.

PUBLICATION ORDERING INFORMATION

LITERATURE FULFILLMENT:

Literature Distribution Center for ON Semiconductor
P.O. Box 5163, Denver, Colorado 80217 USA
Phone: 303-675-2175 or 800-344-3860 Toll Free USA/Canada
Fax: 303-675-2176 or 800-344-3867 Toll Free USA/Canada
Email: orderlit@onsemi.com

N. American Technical Support: 800-282-9855 Toll Free
USA/Canada.

Europe, Middle East and Africa Technical Support:
Phone: 421 33 790 2910

Japan Customer Focus Center
Phone: 81-3-5773-3850

ON Semiconductor Website: www.onsemi.com

Order Literature: <http://www.onsemi.com/orderlit>

For additional information, please contact your local
Sales Representative